

THE PROPERTY OF THE DRAWING IS ESTABLISHED BY LAW. IT IS FORBIDDEN TO PRODUCE OR SHOW IT TO THIRD PART. WITHOUT A WRITTEN AGREEMENT.

Item	Name	Q.ty
1	CA.08.03.011	1
2	CA.08.09.011	1

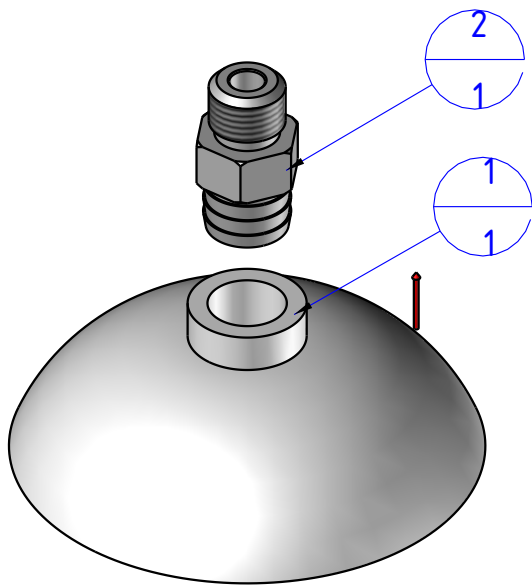
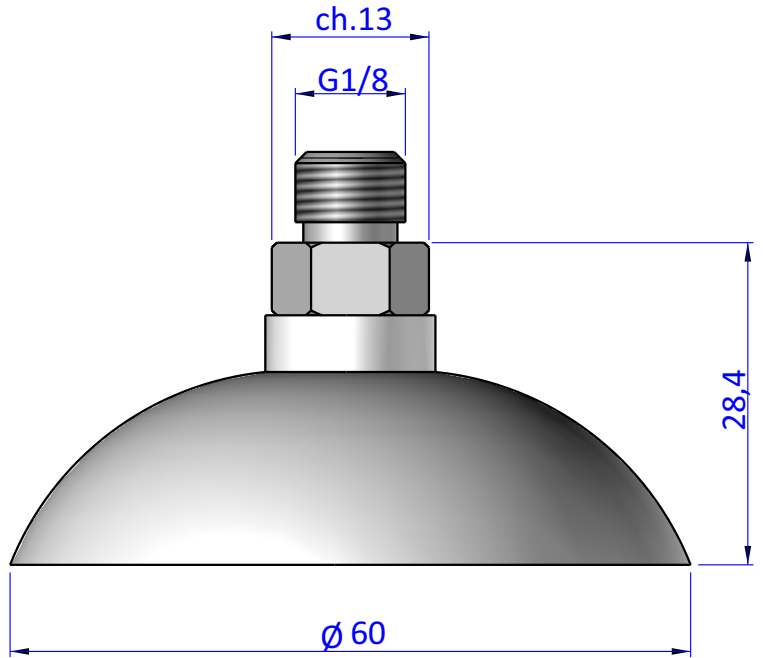

DESIGNED FROM		REVIEW
FPS Automation		A
DATE	WEIGHT	
04/11/2020	0,024kg	
CODE		
KIT.08.03.D60.11		

Format A4

UNI 936-76

GENERAL TOLERANCE

UNI - ISO 2768

CLASSE f

DESCRIPTION

KIT.08.03.D60.11